

# Panasonic

NEW

Amplifier-separated type  
Digital Laser Sensor

LS-500<sub>SERIES</sub>

CE  
Conforming to  
EMC Directive

FDA  
Conforming to  
FDA regulations



Industry's smallest\*  
laser sensor head

*LASER CLASS 1*



Industry's smallest\* head



Stainless steel (SUS) enclosure

Featuring stainless steel (SUS) enclosure that won't break when bumped during installation or maintenance.

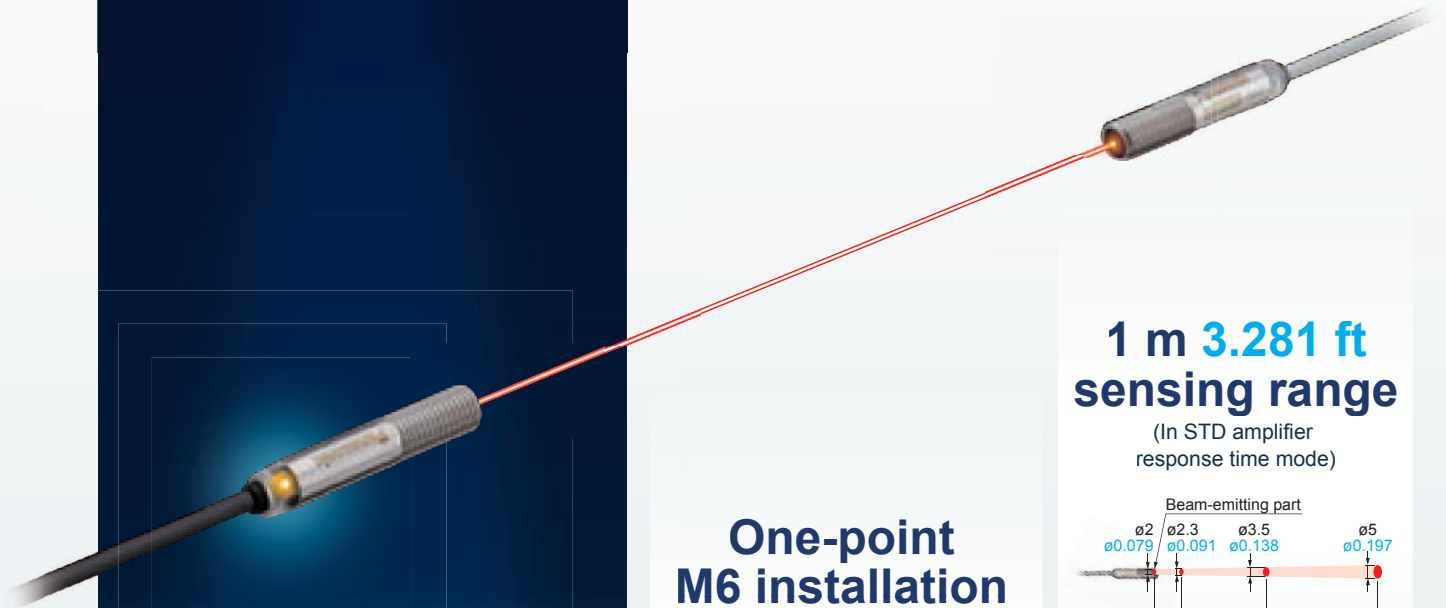

**1 m 3.281 ft**  
**sensing range**

(In STD amplifier response time mode)

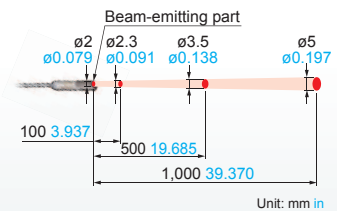

### One-point M6 installation

The LS-H101 features an easy-to-install design.

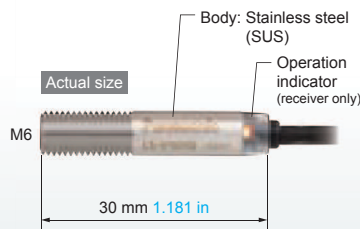

Thru-beam  
M6 head sensing type

**LS-H101**

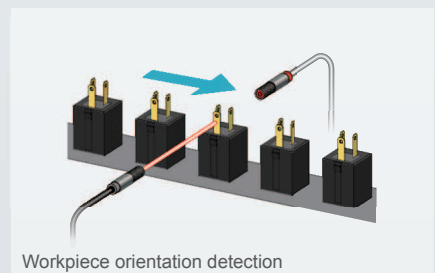
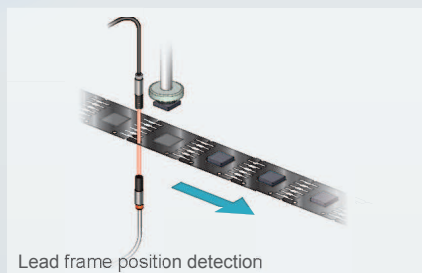
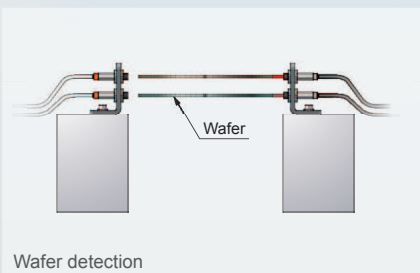

\*Smallest amplifier-separated type laser sensor head as of May 2013 based on research conducted by our company

Industry's smallest\* head



IP67



Thru-beam  
Square side sensing type

**LS-H102**

Featuring waterproof IP67  
to allow use in the  
presence of large amounts  
of water or dust.

### Simple positioning

Check the optimal receiving  
location at a glance while  
watching the red spot on the  
beam axis adjustment screen.



### 1 m 3.281 ft sensing range

(In STD amplifier response time mode)

The **LS-H102** delivers sufficient  
sensing range for use with 450  
mm 17.717 in wafers.



### Two-point installation

The thru-beam type **LS-H102**  
features the same form factor as  
the **EX-L200** ultra-compact laser  
sensor with built-in amplifier,  
and it can be used as an  
**EX-L200** with a digital indicator.  
It also delivers the same bend  
quality as the **EX-L200**.

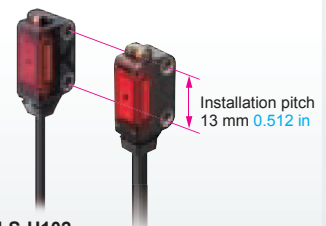

**LS-H102**

**EX-L211 / EX-L212**

Same installation  
pitch as the **EX-L200**  
series

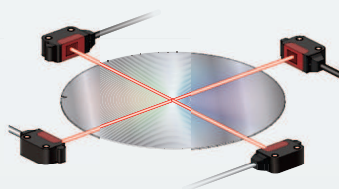

Wafer inclination detection

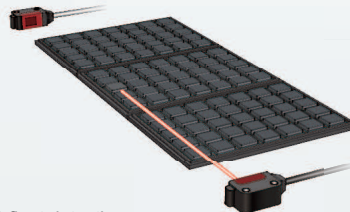

IC float detection

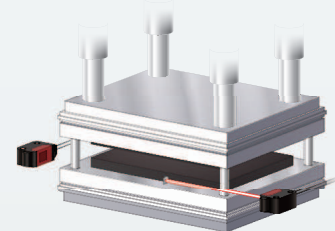

Detection of residual matter inside molds

\*Smallest amplifier-separated type laser sensor head as of May 2013 based on research conducted by our company

Industry's smallest\* head



Thinnest profile

Featuring a 60% smaller design (by volume) than previous coaxial reflective models, our smallest unit is smaller in every dimension at just **W 8 × H 23 × D 18 mm** **W 0.315 × H 0.906 × D 0.709 in** (excluding indicators).

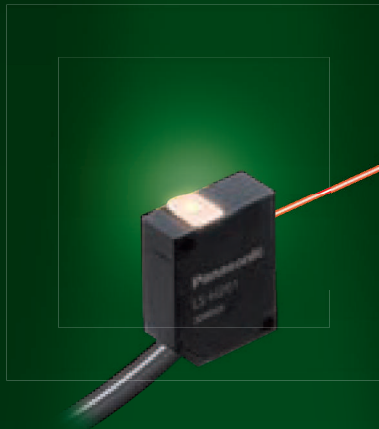
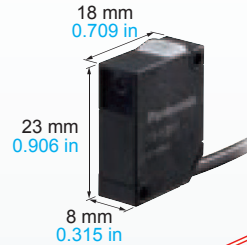

Coaxial reflective type

**LS-H201**

## Small, long-range spot

The **LS-H201** produces a spot with a diameter of 2 mm **0.079 in** at a sensing range of up to 300 mm **11.811 in** (in STD amplifier response time mode).

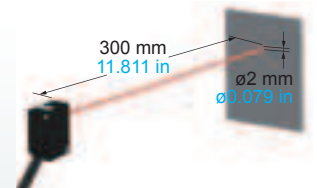

## Coaxial design

By using a laser with high linearity in a coaxial design, the **LS-H201** is able to deliver stable sensing in confined spaces as well as simple installation.

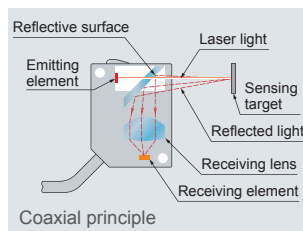

Reflective photoelectric sensor



Coaxial design



## Easy-to-see operation indicator

The **LS-H201**'s operation indicator is visible from all directions.

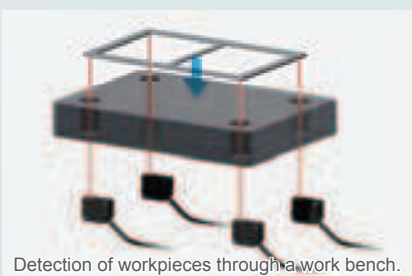

Detection of workpieces through a work bench.

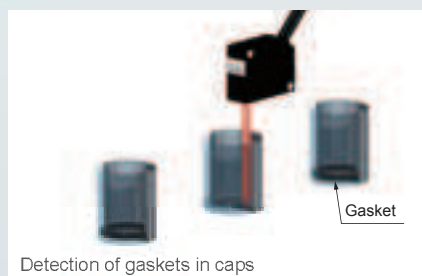

Detection of gaskets in caps



Detection of threaded holes and thread

\*Smallest amplifier-separated type laser sensor head as of May 2013 based on research conducted by our company

Industry's smallest\* head



# Horizontal symmetry

Featuring a simple system design process thanks to a light source that is placed in the center of the sensor head and a coaxial design.

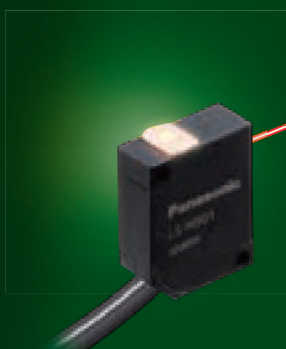
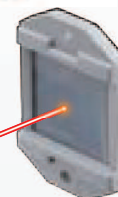
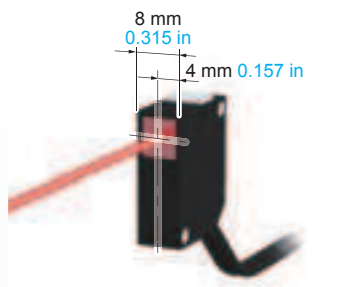

**Sensing range of 10 mm to 1 m**  
**0.394 in to 3.281 ft**

(In STD amplifier response time mode)

The **LS-H901** supports close-range sensing.

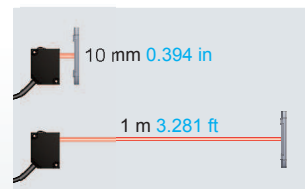

## Industry's smallest\* and thinnest design

The **LS-H901** is even thinner than previous models, measuring just W 8 × H 23 (excluding indicators) × D 18 mm  
W 0.315 × H 0.906 × D 0.709 in.

Coaxial retroreflective type

### LS-H901

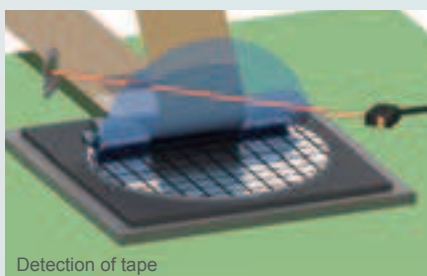

Detection of tape

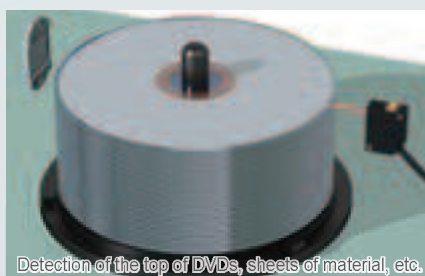

Detection of the top of DVDs, sheets of material, etc.



Detection of bottles

\*Smallest amplifier-separated type laser sensor head as of May 2013 based on research conducted by our company



Among  
industry's  
fastest  
response times\*  
60  $\mu$ s

FX-500 fiber sensor

LS-500 laser sensor



Amplifier

LS-500

Engineered for maximum compatibility with fiber sensors in every aspect of its design, from form factor to operability, the LS-500 delivers an environment that makes it easy to choose a laser sensor.

### Maximum compatibility with fiber sensors

The LS-500 features the same operation, menu displays, and form factor as the FX-500 for increased compatibility with fiber sensors.

### Detection of beam axis misalignment Dual outputs (self-diagnosis output)

The LS-500 can detect any reduction in incident light intensity, for example due to the accumulation of dirt such as dust, and issue an alarm. Output 2 can be set as self-diagnosis output. When you teach the threshold for output 1, output 2 is set accordingly, allowing you to shift the threshold by a previously set margin.

### Stable sensing over the long term

The LS-500's threshold-tracking function helps maintain stable sensing over the long term and reduce maintenance man-hours. The incident light intensity can be checked and the threshold automatically reset at a user-selected interval to track changes in light intensity due to environmental changes (such as dust, etc.) over extended periods of time.

### Logic operations

The LS-500's ability to perform three logic operations (AND, OR, and XOR) on a standalone basis eliminates the need for a dedicated controller, cuts down on wiring, and lowers costs. This functionality can also be combined with the FX-500.





### Data bank

Eight sets of amplifier settings can be stored in the unit's built-in memory. The ability to save and load settings reduces workload when changing the setup in a multi-model production environment.

\*Smallest amplifier-separated type laser sensor head as of May 2013 based on research conducted by our company

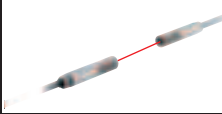
**ORDER GUIDE**

**Sensor heads**

Type		Appearance	Model No.	Sensing range ■ : HYPR ■ : U-LG ■ : LONG ■ : STD ■ : FAST ■ : H-SP
Thru-beam type	Cylindrical		LS-H101	■ : 1 m 3.281 ft ■ : 1 m 3.281 ft ■ : 1 m 3.281 ft ■ : 1 m 3.281 ft ■ : 1 m 3.281 ft ■ : 1 m 3.281 ft
	Square		LS-H102	■ : 1 m 3.281 ft ■ : 1 m 3.281 ft ■ : 1 m 3.281 ft ■ : 1 m 3.281 ft ■ : 1 m 3.281 ft ■ : 1 m 3.281 ft
Coaxial reflective type			LS-H201	■ : 750 mm 29.528 in ■ : 600 mm 23.622 in ■ : 450 mm 17.717 in ■ : 300 mm 11.811 in ■ : 200 mm 7.874 in ■ : 150 mm 5.906 in
Coaxial retroreflective type			LS-H901	■ : 0.01 to 2.5 m 0.033 to 8.202 ft ■ : 0.01 to 2 m 0.033 to 6.562 ft ■ : 0.01 to 1.5m 0.033 to 4.921 ft ■ : 0.01 to 1m 0.033 to 3.281 ft ■ : 0.01 to 1m 0.033 to 3.281 ft ■ : 0.01 to 1m 0.033 to 3.281 ft

**5 m 16.404 ft cable length type**

5 m 16.404 ft cable length types (Standard: 2 m 6.562 ft) are available. When ordering this type, add "-C5" at the end of the model number.

LS-H101-C5

LS-H102-C5

LS-H201-C5

LS-H901-C5



**Package without reflector**

The LS-H901 is also available without a reflector (RF-330).

When ordering this type, add "-Y" at the end of the model number.

LS-H901-Y

**Amplifiers**

Type	Appearance	Model No.	Output	Connection method
Connector type		LS-501	NPN open-collector transistor two outputs	Use quick-connection cable (4-core) (optional)
		LS-501P	PNP open-collector transistor two outputs	
Cable type (With external input)		LS-501-C2	NPN open-collector transistor two outputs	2 m 6.562 ft cabtyre cable (6-core) included Cable outer diameter: ø4 mm ø0.157 in
		LS-501P-C2	PNP open-collector transistor two outputse	

**Quick-connection cables** Quick-connection cable is not supplied with the connector type amplifier. Please order it separately.

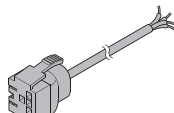
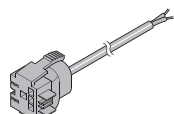
Type	Appearance	Model No.	Description
Main cable (4-core)		CN-74-C1	Length: 1 m 3.281 ft
		CN-74-C2	Length: 2 m 6.562 ft
		CN-74-C5	Length: 5 m 16.404 ft
Sub cable (2-core)		CN-72-C1	Length: 1 m 3.281 ft
		CN-72-C2	Length: 2 m 6.562 ft
		CN-72-C5	Length: 5 m 16.404 ft

**Connectors**

Type	Appearance	Model No.	Description
Connector for amplifier		CN-EP4	Connector included with sensor head Use for maintenance, for example when another connector is damaged.

## ORDER GUIDE

**End plates** End plates are not supplied with the amplifier. Please order separately when the amplifiers are mounted in cascade.

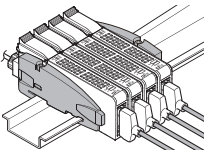
Appearance	Model No.	Description
	<b>MS-DIN-E</b>	When cascading multiple amplifiers, or when it moves depending on the way it is installed on a DIN rail, these end plates clamp amplifiers into place on both sides. Make sure to use end plates when cascading multiple amplifiers together. <b>Two pcs. per set</b>

### Accessories

**MS-LS-1** (Sensor head mounting bracket)  
For use with the **LS-H201** / **LS-H901**

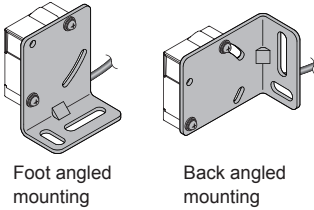

**RF-330** (Reflector)

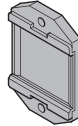

**MS-EXL2-2** (Mounting plate for thru-beam type)

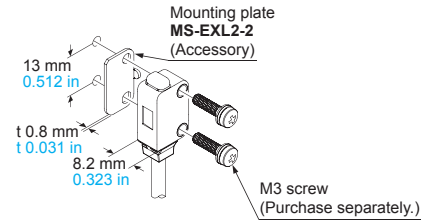

### OPTIONS

Designation	Model No.	Description
Sensor head mounting bracket	<b>MS-EXL2-1</b>	<b>LS-H102</b> (square side sensing use) Foot angled mounting bracket
	<b>MS-EXL2-4</b>	<b>LS-H102</b> (square side sensing use) Universal sensor mounting bracket
	<b>MS-EXL2-5</b>	<b>LS-H102</b> (square side sensing use) Back angled mounting bracket
Amplifier mounting bracket	<b>MS-DIN-2</b>	Mounting bracket for amplifier
Amplifier protective seal	<b>FX-MB1</b>	10 sets of 2 communication window seals and 1 connector seal Communication window seal: It prevents malfunction due to transmission signal from another amplifier, as well as, prevents effect on another amplifier. Connector seal: It prevents contact of any metal, etc., with the pins of the quick-connection cable.
Reflector	<b>RF-310</b>	For coaxial retroreflective type Compact reflector
Reflective tape	<b>RF-31</b>	For coaxial retroreflective type Size: 9.2 × 9.2 × t 0.4 mm <b>0.362 × 0.362 × t 0.016 in</b>
	<b>RF-33</b>	For coaxial retroreflective type Size: 25.2 × 27.8 × t 0.4 mm <b>0.992 × 1.094 × t 0.016 in</b>
		Sensing range Please contact us for details.
		Sensing range Same as the <b>RF-330</b> .

### Sensor head mounting bracket

• **MS-EXL2-1**

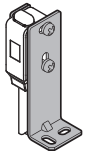

Material: Stainless steel (SUS304)  
Two M3 (length 14 mm **0.551 in**) screws with washers [stainless steel (SUS304)] are attached.

• **MS-EXL2-4**

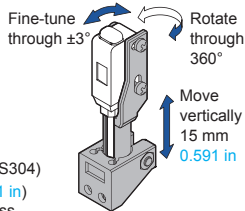

Material: Die-cast zinc alloy  
Stainless steel (SUS304) Two M3 (length 14 mm **0.551 in**) screws with washers [stainless steel (SUS)], one M3 (length 10 mm **0.394 in**) hexagon socket head bolt [stainless steel (SUS)], and one M3 hexagon nut [stainless steel (SUS)] are attached.

• **MS-EXL2-5**

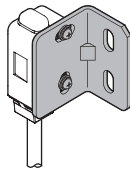

### Reflector

• **RF-310**

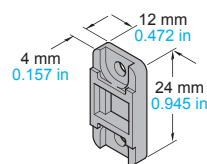

### Reflective tape

• **RF-33**

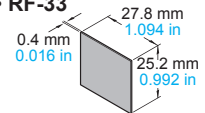

• **RF-31**

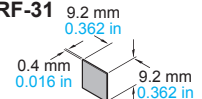

### Amplifier mounting bracket

• **MS-DIN-2**

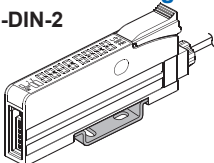

### Amplifier protective seal

• **FX-MB1**

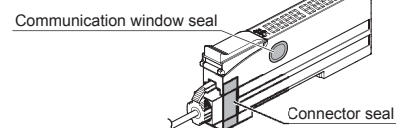



**SPECIFICATIONS**

**Sensor heads**

Item	Type Model No.	Thru-beam type		Coaxial reflective type LS-H201	Coaxial retroreflective type LS-H901
		Cylindrical LS-H101	Small LS-H102		
Applicable amplifiers		LS-501(P), LS-501(P)-C2			
Sensing range	H-SP	1 m 3.281 ft	1 m 3.281 ft	150 mm 5.906 in	0.01 to 1 m 0.033 to 3.281 ft
	FAST	1 m 3.281 ft	1 m 3.281 ft	200 mm 7.874 in	0.01 to 1 m 0.033 to 3.281 ft
	STD	1 m 3.281 ft	1 m 3.281 ft	300 mm 11.811 in	0.01 to 1 m 0.033 to 3.281 ft
	LONG	1 m 3.281 ft	1 m 3.281 ft	450 mm 17.717 in	0.01 to 1.5 m 0.033 to 4.921 ft
	U-LG	1 m 3.281 ft	1 m 3.281 ft	600 mm 23.622 in	0.01 to 2 m 0.033 to 6.562 ft
	HYPR	1 m 3.281 ft	1 m 3.281 ft	750 mm 29.528 in	0.01 to 2.5 m 0.033 to 8.202 ft
Spot size		Approx. ø5 mm ø0.197 in or less (at a distance from the emitter of 1 m 3.281 ft)	Approx. ø5 mm ø0.197 in or less (at a distance from the emitter of 1 m 3.281 ft)	Approx. ø2 mm ø0.079 in or less (at a distance from the emitter of 300 mm 11.811 in)	Approx. ø6 mm ø0.236 in or less (at a distance from the emitter of 1 m 3.281 ft)
Sensing object		Opaque, translucent, or transparent object (Note 3)			
Operation indicator		Orange LED (lights up when the amplifier output is ON)			
Environmental resistance	Protection	IP40 (IEC)	IP67 (IEC)	IP40 (IEC)	IP40 (IEC)
	Ambient temperature	-10 to +55 °C +14 to +131 °F (No dew condensation or icing allowed), Storage: -20 to +70 °C -4 to +158 °F			
	Ambient humidity	35 to 85 % RH, Storage: 35 to 85 % RH			
	Ambient illuminance	Incandescent light: 3,000 lx at the light-receiving face			
	Voltage withstandability	1,000 V AC for one min. between all supply terminals connected together and enclosure			
	Insulation resistance	20 MΩ, or more, with 250 V DC megger between all supply terminals connected together and enclosure			
	Vibration resistance	10 to 500 Hz frequency, 1.5 mm 0.059 in amplitude in X, Y and Z directions for two hours each			
	Shock resistance	100 m/s <sup>2</sup> acceleration (10 G approx.) in X, Y and Z directions for three times each			
Emitting element	Type	Red semiconductor laser diode			
	Peak emission wavelength	660 nm 0.026 mil			
	Laser class	Class 1 (IEC / FDA / JIS)			
	Max. output	2 mW	2 mW	2 mW	1 mW
Material		Enclosure: Stainless steel (SUS303) Cover: Polycarbonate	Enclosure: PBT Cover: Acrylic	Enclosure: PBT, Indicator cover: Polycarbonate, Beam-emitting / -receiving surfaces: Glass	
Cable		0.09 mm <sup>2</sup> 2-core shielded cable, 2 m 6.562 ft long		0.1 mm <sup>2</sup> , single core two parallel shielded cables, 2 m 6.562 ft long	
Weight		Net weight: 50 g approx. Gross weight: 75 g approx.	Net weight: 50 g approx. Gross weight: 70 g approx.	Net weight: 50 g approx. Gross weight: 80 g approx.	Net weight: 50 g approx. Gross weight: 85 g approx.
Accessories		M6 screw: 4 pcs. Toothed lock washer: 2 pcs.	MS-EXL2-2 (mounting plate): 2 pcs.	MS-LS-1 (mounting bracket): 1pc.	MS-LS-1 (mounting bracket): 1pc. RF-330 (reflector): 1pc.

- Notes: 1) Where measurement conditions have not been specified precisely, the conditions used were an ambient temperature of +23 °C +73.4 °F.  
 2) This product complies with 21 CFR 1040.10 and 1040.11 Laser Notice No. 50, dated June 24, 2007, issued by CDRH (Center for Devices and Radiological Health) under the FDA (Food and Drug Administration). For details, refer to the Laser Notice No. 50.  
 3) Make sure to confirm detection with an actual sensor before use.  
 4) The sensing range of the coaxial reflective type sensor is specified for white non-glossy paper (100 × 100 mm 3.937 × 3.937 in) as the object.  
 5) Sensing ranges for coaxial retroreflective type sensors are values for the RF-330 reflector. In addition, the sensing range is the possible setting range for the reflector. The sensor can detect an object less than 0.01 m 0.033 ft away. Note that due to the principles on which coaxial retroreflective sensors operate, if a mirrored object or other object that diffuses light readily is located close to the sensor, polarized light from these objects may be received, causing unstable sensing. In such cases, use the amplifier unit's receiving sensitivity function to lower the sensitivity, change the response time, or move the sensor head away from the target object. The incident light intensity may vary with the condition of the reflector surface. When using one of the applicable LS-500 series amplifiers, leave an adequate safety margin when setting the threshold.  
 6) When using the thru-beam type LS-H101□ or LS-H102□, do not set the receiving light sensitivity (gctL) of the applicable LS-500 series amplifier to level 2 or less. This is because there is a possibility of sensing becoming unstable.  
 7) Cable cannot be extended.

**SPECIFICATIONS**

**Amplifiers**

Item	Model No.	Type	Connector type	Cable type
		NPN Output	<b>LS-501</b>	<b>LS-501-C2</b>
		PNP Output	<b>LS-501P</b>	<b>LS-501P-C2</b>
Supply voltage	12 to 24 V DC $^{+10}_{-15}$ % Ripple P-P 10 % or less			
Power consumption	Normal operation: 1,200 mW or less (Current consumption 50 mA or less at 24 V supply voltage) ECO mode: 980 mW or less (Current consumption 40 mA or less at 24 V supply voltage)			
Outputs (Output 1, Output 2)	<NPN output type> NPN open-collector transistor		<PNP output type> PNP open-collector transistor	
	<ul style="list-style-type: none"> <li>Maximum sink current: 50 mA (Note 2)</li> <li>Applied voltage: 30 V DC or less (between output and 0 V)</li> <li>Residual voltage: 2 V or less (at max. sink current)</li> </ul>		<ul style="list-style-type: none"> <li>Maximum source current: 50 mA (Note 2)</li> <li>Applied voltage: 30 V DC or less (between output and +V)</li> <li>Residual voltage: 2 V or less (at max. source current)</li> </ul>	
	Output operation	Selectable either Light-ON or Dark-ON		
	Short-circuit protection	Incorporated		
Sensing output setting	Output 1	Normal mode, differential mode, hysteresis mode, window comparator mode, selectable		
	Output 2	Normal mode, differential mode, hysteresis mode, self-diagnostic output mode, selectable	Normal mode, differential mode, hysteresis mode, self-diagnostic output mode, answer-back output mode, selectable	
Response time	H-SP: 60 μs or less, FAST: 150 μs or less, STD: 250 μs or less, LONG: 500 μs or less, U-LG: 5 ms or less, HYPR: 24 ms or less, selectable			
Monitor current output	_____		Output current: Approx. 4 to 20 mA (H-SP, FAST, STD: at 0 to 4,000 indication) Response time: 2 ms or less Zero point: 4 mA ± 1% F.S. Span: 16 mA ± 5 % F.S. Linearity: ± 3 % F.S. Load resistance: 0 to 250 Ω	
External input	<NPN output type> NPN non-contact input		<PNP output type> PNP non-contact input	
	<ul style="list-style-type: none"> <li>Signal condition High: +8 V to +V DC or open, Low: 0 to +2 V DC (source current 0.5 mA or less)</li> <li>Input impedance: 10 kΩ approx.</li> </ul>		<ul style="list-style-type: none"> <li>Signal condition High: +4 V to +V DC (sink current 3.0 mA or less), Low: 0 to +0.6 V DC or open</li> <li>Input impedance: 10 kΩ approx.</li> </ul>	
External input function	Laser emission halt / teaching (full-auto teaching, limit teaching, 2 point teaching) / logic operation setting / copy lock / display adjustment / data bank load / data bank save, selectable			
Operation indicator	Orange LED (lights up when output 1 and output 2 are ON)			
Laser emission indicator	Green LED (lights up during laser emission)			
Output select indicator	Yellow LED (lights up when output is selected)			
Digital display	8-digit 7-segment digital display (4-digit green LED + 4-digit red LED), MODE indicator (Yellow LED): L/D, CUST, PRO			
Incident light indication range	H-SP / FAST / STD: 0 to 4,000, LONG / U-LG / HYPR: 0 to 9,999			
Sensitivity setting	2-level teaching / limit teaching / full auto teaching / manual adjustment			
Logical operation	Between sensing output 1 and calculation target: Disabled / and / or / xor, selectable Calculation target: Sensing output 2 / adjacent upstream amplifier (sensing output 1) / external input, selectable			
Timer functions	<Output 1> OFF-delay timer, ON-delay timer, ONE-SHOT timer, ON / OFF-delay timer, ON-delay / ONE-SHOT timer, switchable either effective of ineffective			
	<Output 2> OFF-delay timer, ON-delay timer, ONE-SHOT timer, switchable either effective of ineffective			
	Timer period	Timer range "ms": 0.5 ms approx., 1 to 9,999 ms approx., in approx. 1 ms intervals Timer range "sec": 0.5 sec approx., 1 to 32 sec approx., in approx. 1 sec intervals Timer range "1/10 ms": 0.05 ms approx., 0.1 to 999.9 ms approx., in approx. 0.1 ms intervals Set separately for each output.		
Interference prevention function	Incorporated (Note 3)			
Environmental resistance	Ambient temperature	-10 to +55°C +14 to +131 °F (If 4 to 7 units are mounted close together, -10 to +50°C +14 to +122 °F; if 8 to 16 units (cable type: 8 to 12 units) are mounted close together, -10 to +45 °C +14 to +113°F) (No dew condensation or icing allowed), Storage: -20 to +70 °C -4 to +158 °F		
	Ambient humidity	35 to 85 % RH, Storage: 35 to 85 % RH		
	Voltage withstandability	1,000 V AC for one min. between all supply terminals connected together and enclosure		
	Insulation resistance	20 MΩ, or more, with 250 V DC megger between all supply terminals connected together and enclosure		
	Vibration resistance	10 to 150 Hz frequency, 0.75 mm 0.030 in amplitude in X, Y and Z directions for two hours each		
	Shock resistance	98 m/s <sup>2</sup> acceleration (10 G approx.) in X, Y and Z directions for five times each		
Material	Enclosure: polycarbonate, Protective cover: Polycarbonate, Switch: Polyacetal			
Protection	IP40 (IEC)			
Cable	_____		0.2 mm <sup>2</sup> 6-core cabtyre cable, 2 m 6.562 ft long	
Cable extension	Extension up to total 100 m 328.084 ft is possible with 0.3 mm <sup>2</sup> , or more, cable.			
Weight	Net weight: 15 g approx., Gross weight: 55 g approx.		Net weight: 75 g approx., Gross weight: 110 g approx.	
Accessory	<b>FX-MB1</b> (Amplifier protective seal): 1 set			

Notes: 1) Where measurement conditions have not been specified precisely, the conditions used were an ambient temperature of +23 °C +73.4 °F.  
2) 25 mA if 5 or more amplifier are connected in cascade (excluding cable extension).  
3) Number of units that can be mounted close together: 0 for H-SP; 2 for FAST; 4 for STD, LONG, U-LG, or HYPR

## I/O CIRCUIT AND WIRING DIAGRAMS

### NPN output type

#### I/O circuit diagram

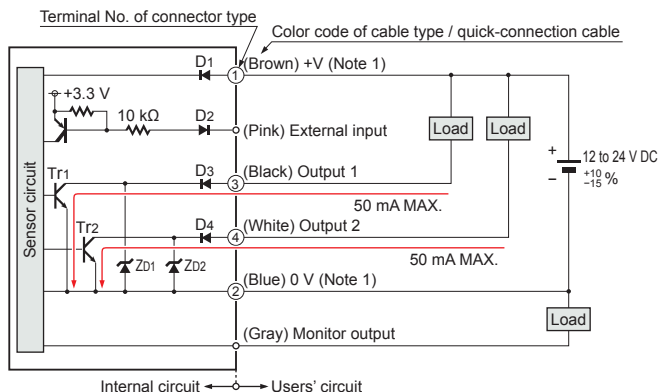

Notes: 1) The quick-connection sub cable does not have +V (brown) and 0 V (blue).  
The power is supplied from the connector of the main cable.

\*1

Non-voltage contact or NPN open-collector transistor

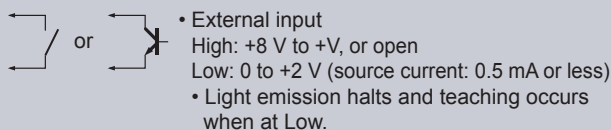

Symbols ... D1, D2, D3, D4: Reverse supply polarity protection diode  
ZD1, ZD2: Surge absorption zener diode  
Tr1, Tr2 : NPN output transistor

#### Wiring diagram

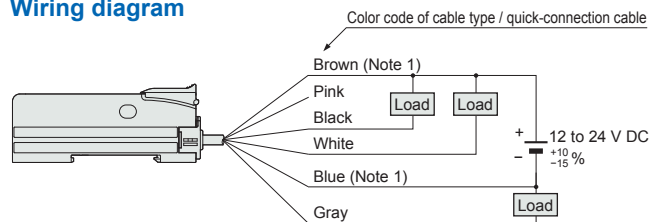

Notes: 1) The quick-connection sub cable does not have brown lead wire and blue lead wire. The power is supplied from the connector of the main cable.  
2) The quick-connection cable does not have gray or pink lead wires.

#### Terminal layout of connector type

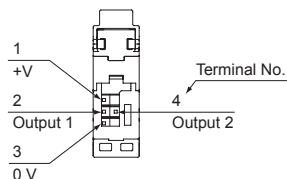

#### \* Connector for amplifier (CN-EP4) pin position

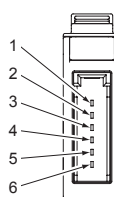

Terminal No.	Connection cable
①	Purple
②	White
③	Shield
④	Shield
⑤	Black
⑥	Pink

### PNP output type

#### I/O circuit diagram

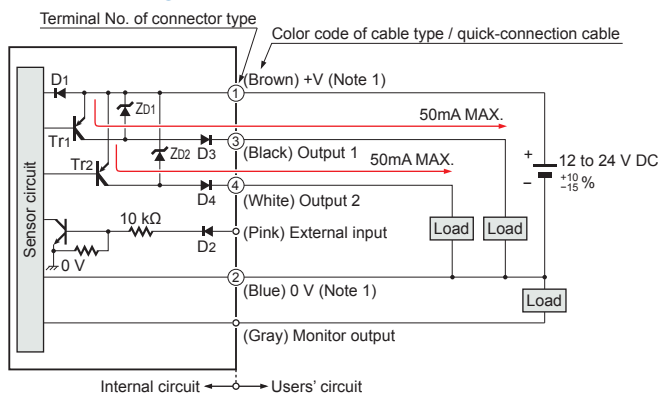

Notes: 1) The quick-connection sub cable does not have +V (brown) and 0 V (blue).  
The power is supplied from the connector of the main cable.

\*1

Non-voltage contact or PNP open-collector transistor

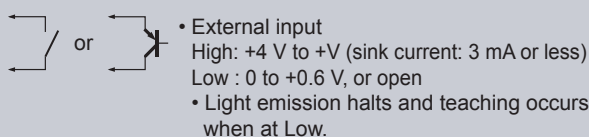

Symbols ... D1, D2, D3, D4: Reverse supply polarity protection diode  
ZD1, ZD2: Surge absorption zener diode  
Tr1, Tr2 : PNP output transistor

#### Wiring diagram

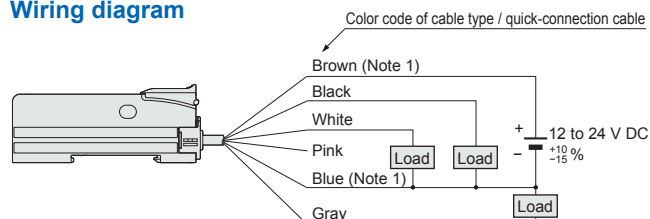

Notes: 1) The quick-connection sub cable does not have brown lead wire and blue lead wire. The power is supplied from the connector of the main cable.  
2) The quick-connection cable does not have gray or pink lead wires.

#### Terminal layout of connector type

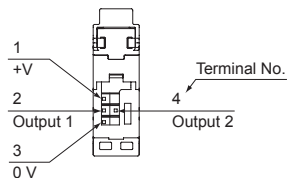

#### \* Connector for amplifier (CN-EP4) pin position

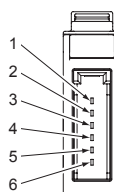

Terminal No.	Connection cable
①	Purple
②	White
③	Shield
④	Shield
⑤	Black
⑥	Pink

## ■ PRECAUTIONS FOR PROPER USE

• This catalog is a guide to select a suitable product. Be sure to read the instruction manual attached to the product prior to its use.



- Never use this product as a sensing device for personnel protection.
- In case of using sensing devices for personnel protection, use products which meet regulations and standards, such as OSHA, ANSI or IEC etc., for personnel protection applicable in each region or country.

### Cautions for laser beams



- These products are Class 1 laser in compliance with IEC, JIS and FDA regulations. To reduce the risk of danger, do not look directly at the laser beam or view it through an optical system.
- A label with instructions as found at the below is affixed to the product. Handle this sensor as per the instruction on the labels.

Panasonic Industrial Devices SUNX Co., Ltd.  
2431-1, Ushiyama-cho, Kasugai,  
Aichi, 486-0901 Japan  
Complies with 21 CFR 1040.10 and 1040.11  
except for deviations pursuant to Laser Notice  
No.50, dated June 24, 2007.  
MANUFACTURED



• The safety standard IEC 60825-1-2001 specifies the use of laser beam products. Please read it carefully before using the laser beam sensor.

### Part description (Amplifier)

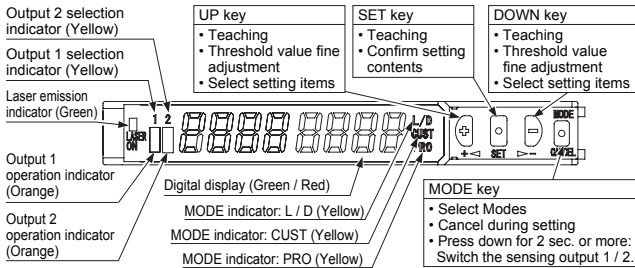

### Mounting

#### Amplifier

##### <How to mount the amplifier>

- (1) Fit the rear part of the mounting section of the amplifier on a 35 mm 1.378 in width DIN rail.
- (2) Press down the rear part of the mounting section of the unit on the 35 mm 1.378 in width DIN rail and fit the front part of the mounting section to the DIN rail.

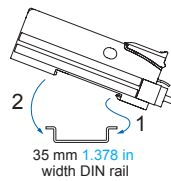

##### <How to remove the amplifier>

- (1) Push the amplifier forward.
- (2) Lift up the front part of the amplifier to remove it.

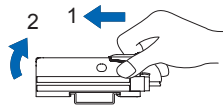

Note: Be careful. If the front part is lifted without pushing the amplifier forward, the hook on the rear portion of the mounting section is likely to break.

##### <How to mount the sensor head>

- (1) Insert the sensor head connector into the inlet until it clicks.
- (2) Fit the cover to the connector.

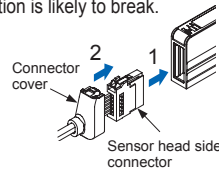

#### Sensor head

##### LS-H101□

- The tightening torque should be 0.98 N·m or less.

##### LS-H102□

- In case mounting this product, use a metal plate MS-EXL2-2 (accessory).
- The tightening torque should be 0.5 N·m or less with M3 screws.

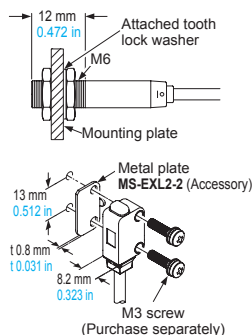

- In case using the dedicated sensor mounting bracket MS-EXL2-1 (optional) when mounting this product, the metal plate MS-EXL2-2 (accessory) is required depending on the mounting direction. Mount as the diagram below indicates.

##### <Not requiring the metal plate>

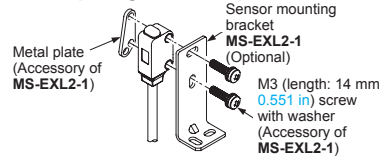

##### <Requiring the metal plate>

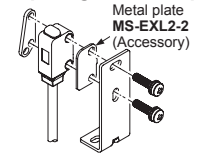

##### LS-H201□, LS-H901□

- The tightening torque should be 0.5 N·m or less.
- When placing the sensor horizontally or vertically, the reflector must also be positioned horizontally or vertically as shown in Fig. 1 below. If the sensor is placed horizontally or vertically but the mirror is tilted as shown in Fig. 2 below, the reflection amount will decrease, which may cause unstable detection.

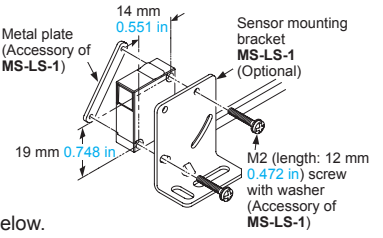

### Fig. 1 Proper positioning

When placing the sensor horizontally or vertically, the reflector shall also be positioned horizontally or vertically.

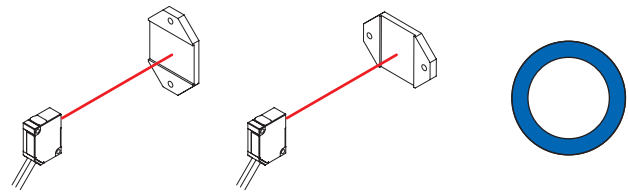

### Fig. 2 Improper positioning

When placing the reflector tilted even when the sensor is positioned horizontally or vertically.

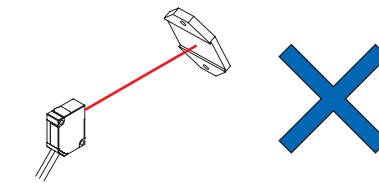

### Wiring

- Make sure that the power supply is off while wiring.
- Verify that the supply voltage variation is within the rating.
- Take care that if a voltage exceeding the rated range is applied, or if an AC power supply is directly connected, the sensor may get burnt or damaged.
- If power is supplied from a commercial switching regulator, ensure that the frame ground (F.G.) terminal of the power supply is connected to an actual ground.
- In case noise generating equipment (switching regulator, inverter motor, etc.) is used in the vicinity of this product, connect the frame ground (F.G.) terminal of the equipment to an actual ground.
- Take care that short-circuit or wrong wiring of the load may burn or damage the sensor.
- Do not run the wires together with high-voltage lines or power lines or put them in the same raceway. This can cause malfunction due to induction.
- Ensure that an isolation transformer is utilized for the DC power supply. If an auto transformer is utilized, the main amplifier or power supply may be damaged.
- Make sure to use the optional quick-connection cable for the connection of the amplifier [connector type LS-501(P)]. Extension up to total 100 m 328.084 ft is possible with 0.3 mm<sup>2</sup>, or more, cable. However, in order to reduce noise, make the wiring as short as possible. Set the supply voltage after considering the voltage drop caused by the cable's resistance. When adding units, wiring length must not exceed 50 m 164.042 ft (for 5 to 8 sensors) or 20 m 65.617 ft (for 9 to 16 sensors).

## PRECAUTIONS FOR PROPER USE

### Others

- Do not use during the initial transient time (0.5 sec. approx.) after the power supply is switched on.
- Because the sensitivity is higher in U-LG and HYPER modes than in other modes, it can be more easily affected by extraneous noise. Check the operating environment before use.
- This sensor is suitable for indoor use only.
- Avoid dust, dirt, and steam.
- Take care that the product does not come in direct contact with water, oil, grease, or organic solvents, such as, thinner, etc.
- This sensor cannot be used in an environment containing inflammable or explosive gasses.
- Never disassemble or modify the sensor.

## DIMENSIONS (Unit: mm in)

The CAD data in the dimensions can be downloaded from our website.

### LS-H101□

### Sensor head

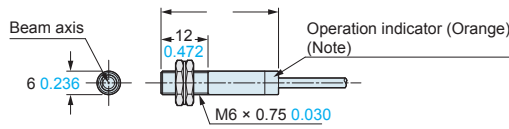

Note: Not incorporated on the emitter.

### LS-H102□

### Sensor head

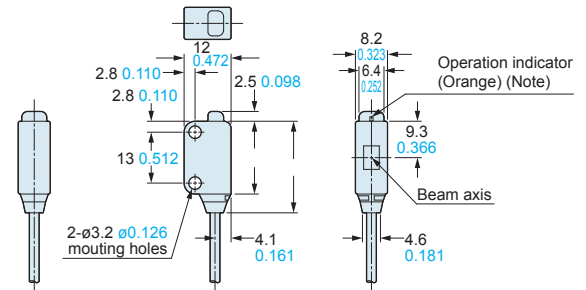

Note: Not incorporated on the emitter.

### LS-H201□ LS-H901□

### Sensor head

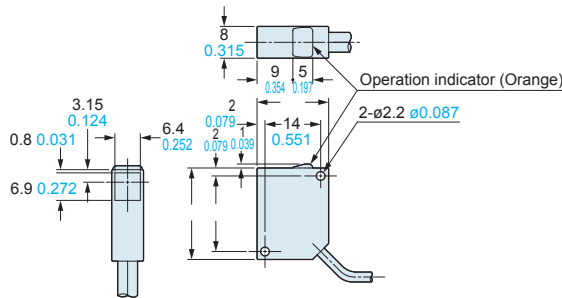

### LS-501-C LS-501P-C

### Amplifier

### LS-501 LS-501P

### Amplifier

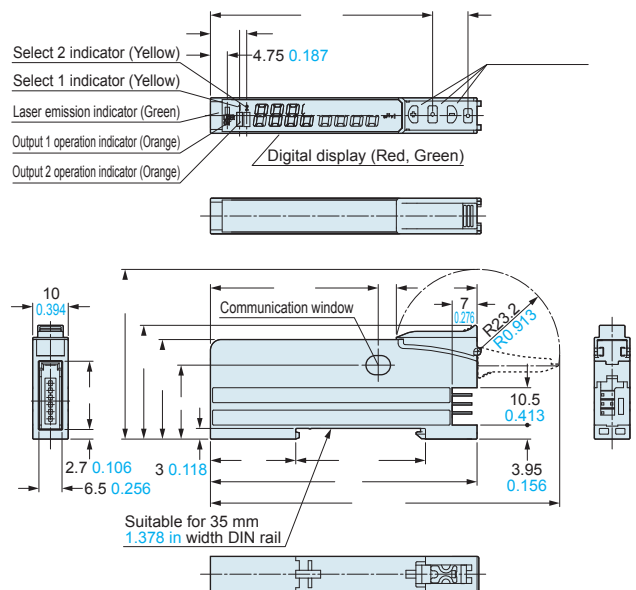



## DIMENSIONS (Unit: mm in)

The CAD data in the dimensions can be downloaded from our website.

### CN-74-C1 CN-74-C2 CN-74-C5 Main cable (Optional)

• Length (L)

Model No.	Length (mm in)
CN-74-C1	1,000 39.370
CN-74-C2	2,000 78.740
CN-74-C5	5,000 196.850

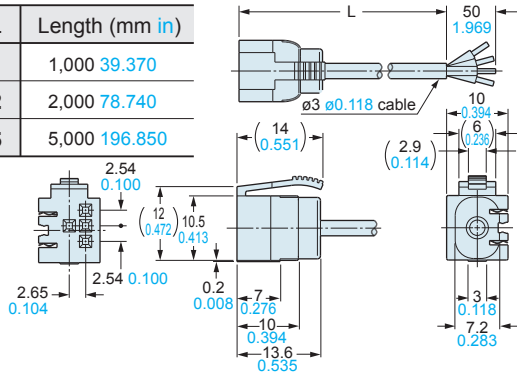

### CN-72-C1 CN-72-C2 CN-72-C5 Sub cable (Optional)

• Length (L)

Model No.	Length (mm in)
CN-72-C1	1,000 39.370
CN-72-C2	2,000 78.740
CN-72-C5	5,000 196.850

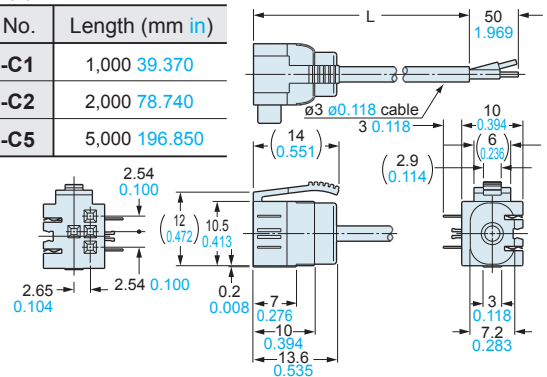

### MS-DIN-E End plate (Optional)

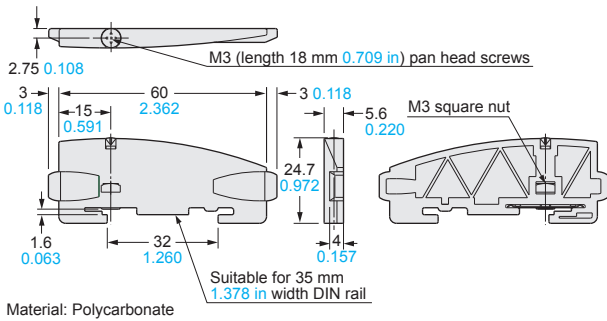

### RF-330 Reflector (Accessory for LS-H901□)

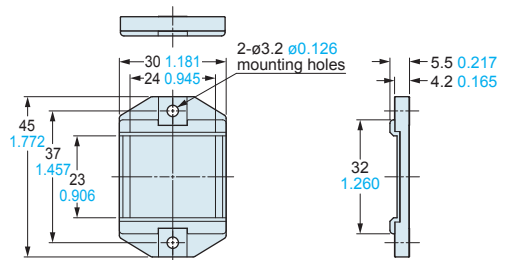

### RF-310 Reflector (Optional)

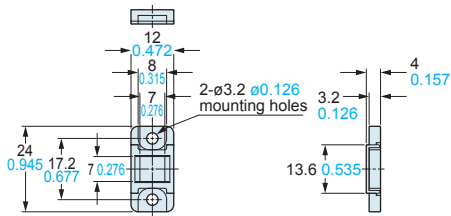

Material: Acrylic (Reflector)  
ABS (Base)

### RF-33 RF-31 Reflective tape (Optional)

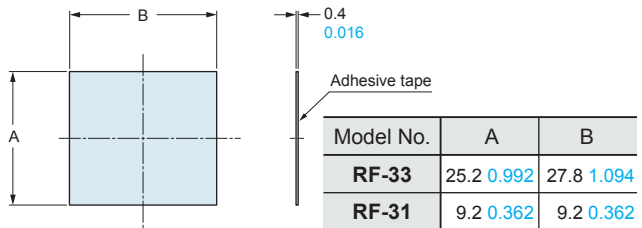

### MS-DIN-2 Amplifier mounting bracket (Optional)

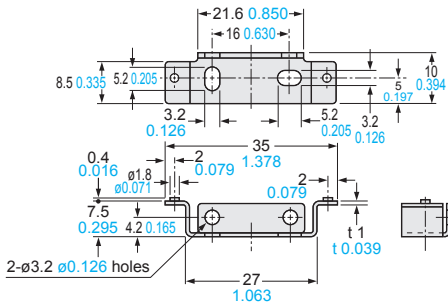

Material: Cold rolled carbon steel (SPCC)  
(Uni-chrome plated)



## Related Products

Digital fiber sensor  
**FX-500 SERIES Ver.2**

## At the industry's leading edge

Featuring superior stability and sharpness



Standard type  
**FX-501 (P)**  
Two-output type  
**FX-502 (P)**  
Cable type  
**FX-505 (P)-C2**

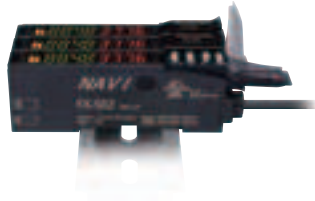

- **Reduced inter-unit differences**  
Thanks to increased stability of the incident light intensity, units will indicate similar readings, even if the amplifier is replaced.
- **Sharp sensing**  
In addition to these sensors' low hysteresis, their hyper beam feature boosts the sensing range.
- **Flat display with a wide field of view**  
The high-brightness, 7-segment display can be seen clearly, even from an angle.

Amplifier built-in ultra compact laser sensor  
**EX-L200 SERIES**

## Built-in amplifier at this size?

Delivering high-precision sensing in the world's smallest\* package

\*Smallest laser sensor with a built-in amplifier as of June 2012 based on research conducted by our company.

### ■ Ultra-compact type

Thanks to a dedicated custom IC and a new design, the **EX-L200** is more than 50% smaller by volume than a general-purpose beam sensor.

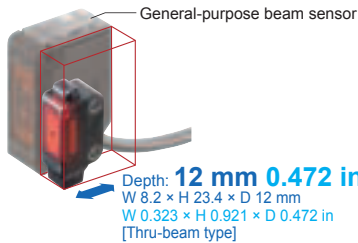

### ■ Laser beam with little dispersion

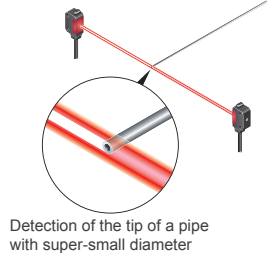

### Thru-beam

Minute object sensing type

#### EX-L211 (-P)

Spot diameter: 6 × 4 mm  
**0.236 × 0.157 in**  
(at a setting distance from the emitter of 1 m **3.281 ft**)

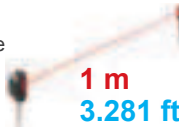

### Thru-beam

Long-range sensing type

#### EX-L212 (-P)

Spot diameter: 8 × 5.5 mm  
**0.315 × 0.217 in**  
(at a setting distance from the emitter of 1 m **3.281 ft**)

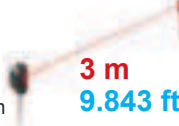

### Retroreflective

Long-range sensing type

#### EX-L291 (-P)

Spot diameter: 6 × 4 mm  
**0.236 × 0.157 in**  
(at a setting distance from the sensor of 1 m **3.281 ft**)



### Spot reflective

Minute object detection type

#### EX-L221 (-P)

Spot diameter: ø1 mm  
**0.039 in or less**  
(at a setting distance from the sensor of 300 mm **11.811 in**)

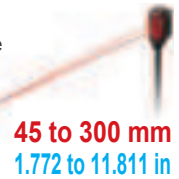

### Convergent reflective

Spot type

#### EX-L261 (-P)

Spot diameter: ø1 mm  
**0.039 in or less**  
(at a setting distance from the sensor of 50 mm **1.969 in**)



### Convergent reflective

Line spot type

#### EX-L262 (-P)

Spot diameter: 1 × 5 mm  
**0.039 × 0.197 in**  
(at a setting distance from the sensor of 50 mm **1.969 in**)



Please contact .....

## Panasonic Industrial Devices SUNX Co., Ltd.

2431-1 Ushiyama-cho, Kasugai-shi, Aichi, 486-0901, Japan

Global Sales Department

■ Telephone: +81-568-33-7861 ■ Facsimile: +81-568-33-8591

[panasonic.net/id/pidsx/global](http://panasonic.net/id/pidsx/global)

**Panasonic**<sup>®</sup>

All Rights Reserved ©Panasonic Industrial Devices SUNX Co., Ltd. 2013